

Z500H+ZHF-32/25 Control Unit Easy User Manual

1、 Before powering on

Connect the IO output line and the plug of the measuring device to the corresponding socket of the control instrument. After confirming the electrical connection between the output line and the machine tool is correct, power on again.

2、 Zero position adjustment

- 1) Select a standard component to install on the machine tool;
- 2) Adjust the position of the upper and lower measuring elements to ensure that the measuring device does not touch the surface of the workpiece after entering the measuring station;



3) In the main page mode, switch to manual mode by clicking button  to .

4) Click in sequence  →  → , Enter the device reset interface.

- a. Click reset to complete the reset and compensation value reset;
- b. Adjust the position of the lower sensor so that the displayed value of sensor 1 is around 0 (preferably within $\pm 10 \mu\text{m}$) and lock tightly;
- c. Adjust the position of the upper sensor so that the displayed value of sensor 2 is around 0 (preferably within $\pm 10 \mu\text{m}$) and lock tightly;
- d. Manually operate the machine tool to repeat the device in and out several times, and

finally stop at the measurement station and click the button  to complete the zero position adjustment.

3、 Parameter settings

1. Click  to enter the main page, click on **【PROG】**, select **【SURFACE ELABORATION PARAMETERS】**, click on the right side , select "Reciprocating motion" and check it.

2. The following parameters are factory default parameters:

- ★① [Waiting time]=10; [Measurement time]=0; [Algorithm Type]=Derivative;
- ★② [Surface Grinding Type] → [Analog Parameters]; Derivative limit=1.0; [Derivative time]=4;

To modify, follow the steps below:

Click on the top left corner  to return to the "Grinding Surface Type" page and select "Intermittent Surface Parameters".

After setting the parameters, click to  return to the **【PROG】** page and click **【Save】**.

Note: The parameters ★① and ★② are modified according to the different working conditions of the machine tool, mainly depending on the smoothness of the light column changes, the amplitude of the displayed values, and the changes in the final retained values.

3、 Setting of signal points

After clicking the left button  to enter the main page interface, click in sequence



CONTROLS MODIFY

Enter the measurement control point setting interface

MEAS CONTROL 3: Brief grinding signal point;











MEAS CONTROL 2: Refined grinding signal point;

MEAS CONTROL 1: Buffing grinding signal point;

The default signal point for tool retraction is 0;

Setting values: MEAS CONTROL 3 > MEAS CONTROL 2 > MEAS CONTROL 1;

4. Adjustment function

- 1) After setting the zero position and signal points, click to  →  →  enter the measurement interface;
- 2) Click the button  to switch to , and the controller is in automatic mode;
- 3) Click on the bottom left corner  to perform a 0.5 compensation operation;
- 4) After clicking the button , enter the "Zero Adjustment" interface, and perform 1 μ m compensation operation by clicking  and . Alternatively, click  and set the desired compensation value through the numeric keypad.

Note:

Manual adjustment+operation will reduce the grinding allowance, while manual adjustment - operation will increase the grinding allowance;

The controller only outputs the status of four signal points when it receives the judgment start input signal in automatic mode.

User Connection

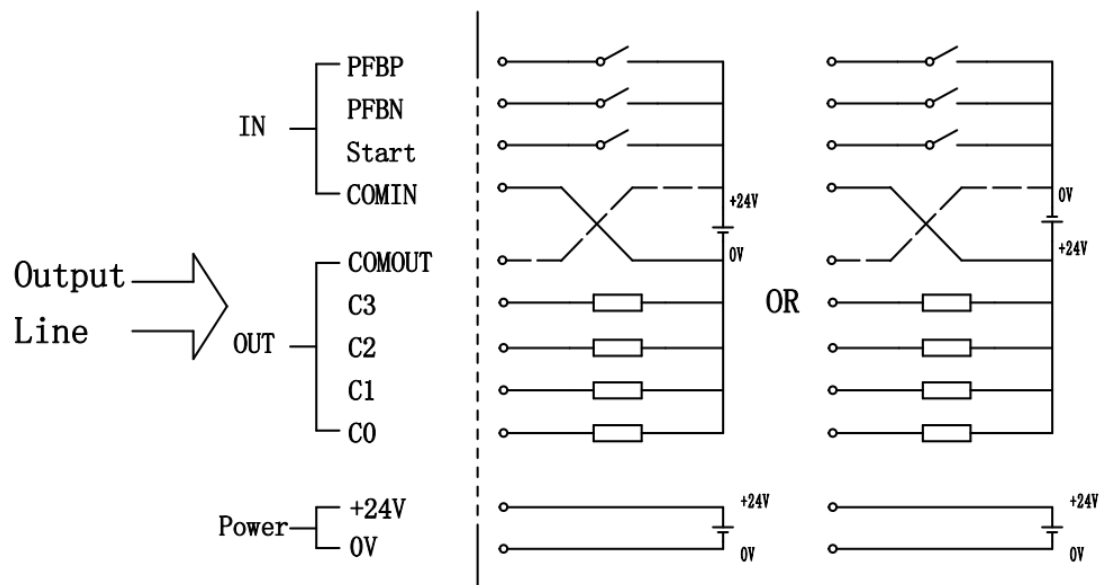

Number	I/O	Line color	Remarks
1	OUT_C0	Light green	P4
4	OUT_C1	Brown/White	P3
5	OUT_C2	Yellow	P2

6	OUT_C3	Red/White	P1
8	DC: +24V	Purple	
9	DC: +24V	Red	
16	COMIN	White	
19	COMOUT	Green/Black	
20	IN_PFBP	Yellow/Black	Increase grinding allowance
21	IN_PFBN	Orange/Black	Reduce grinding allowance
23	IN_START	Purple/White	
26	DC: 0V	Black	

2024/4/15